

HDT80



product guide



features

- 13,228 lb. maximum load capacity
- 147'-8" maximum operating hook radius
- 176'-2" maximum hook height with jib set at 30 degrees
- 112'-2" maximum hook height with jib set at 0 degrees
- 10 different jib configurations
- 3 different mast heights
- Trolley speeds up to 190 ft/min with 7,937 lbs and 144 ft/min with 13,228 lbs
- Swing speeds up to 0.8 rpm
- Manitowoc CraneCARE comprehensive support

*with optional equipment

contents

| | |
|--------------------|---|
| Outline Dimensions | 2 |
| Outline Dimensions | 3 |
| Rated Load Charts | 4 |
| Rated Load Charts | 5 |
| Mechanical Data | 6 |
| Crane Care | 7 |

outline dimensions

2

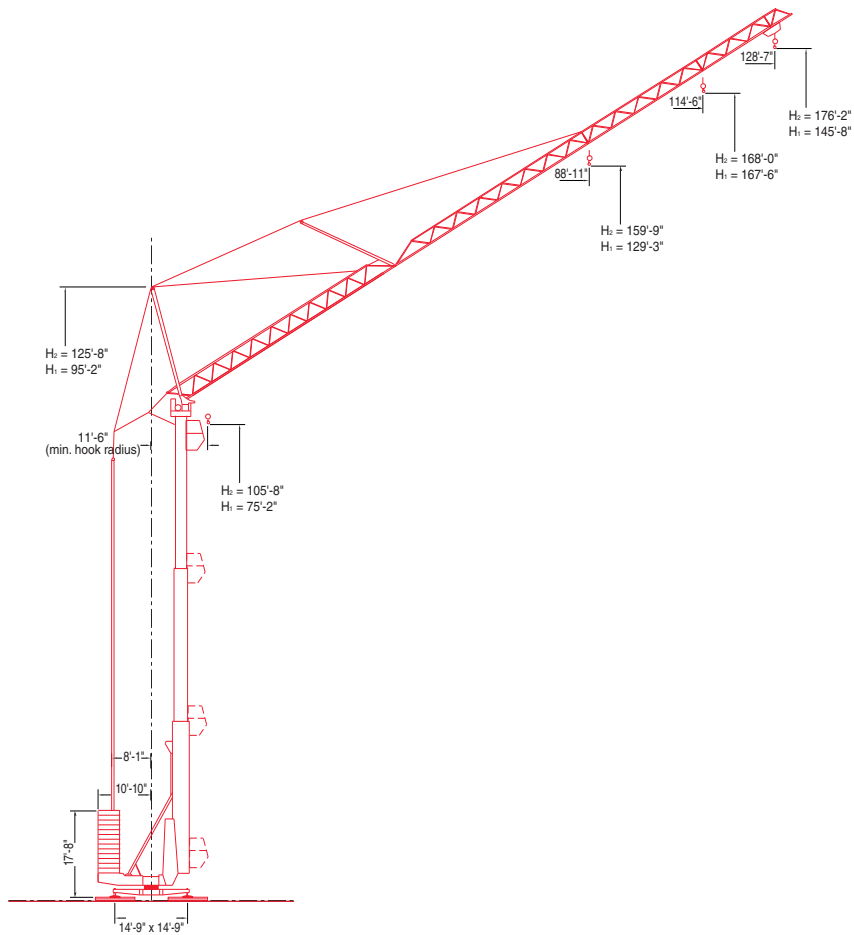
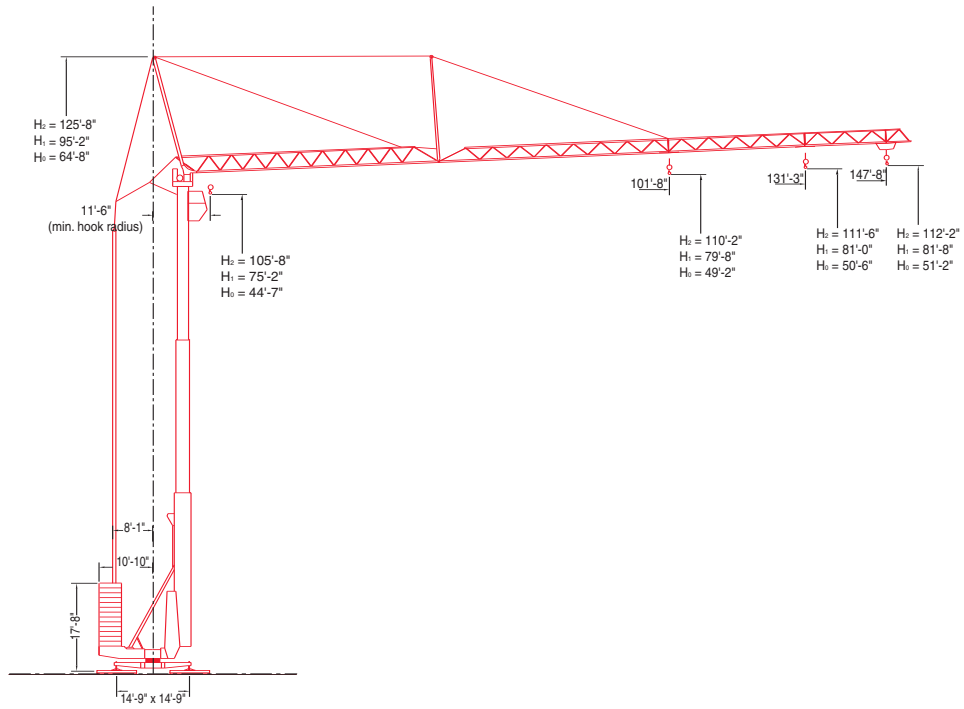

HDT80

outline dimensions

3

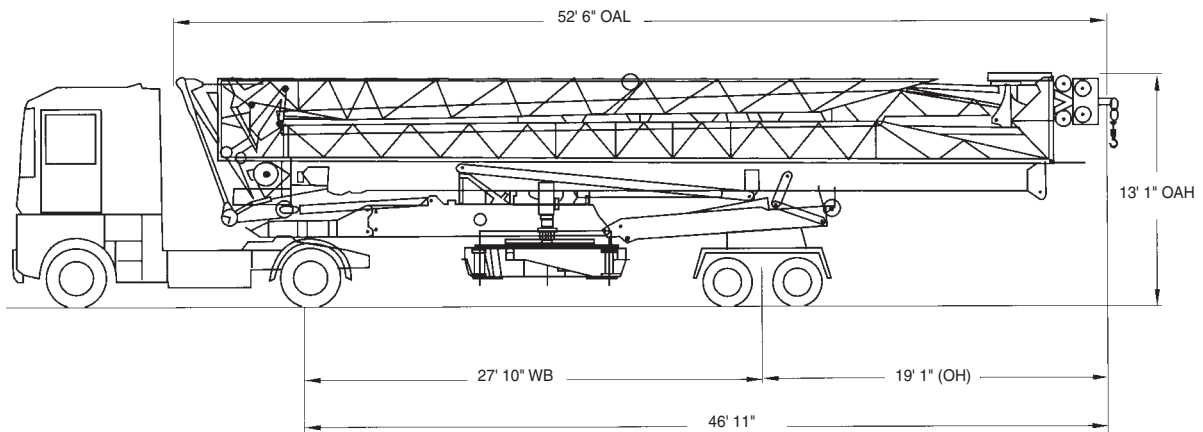
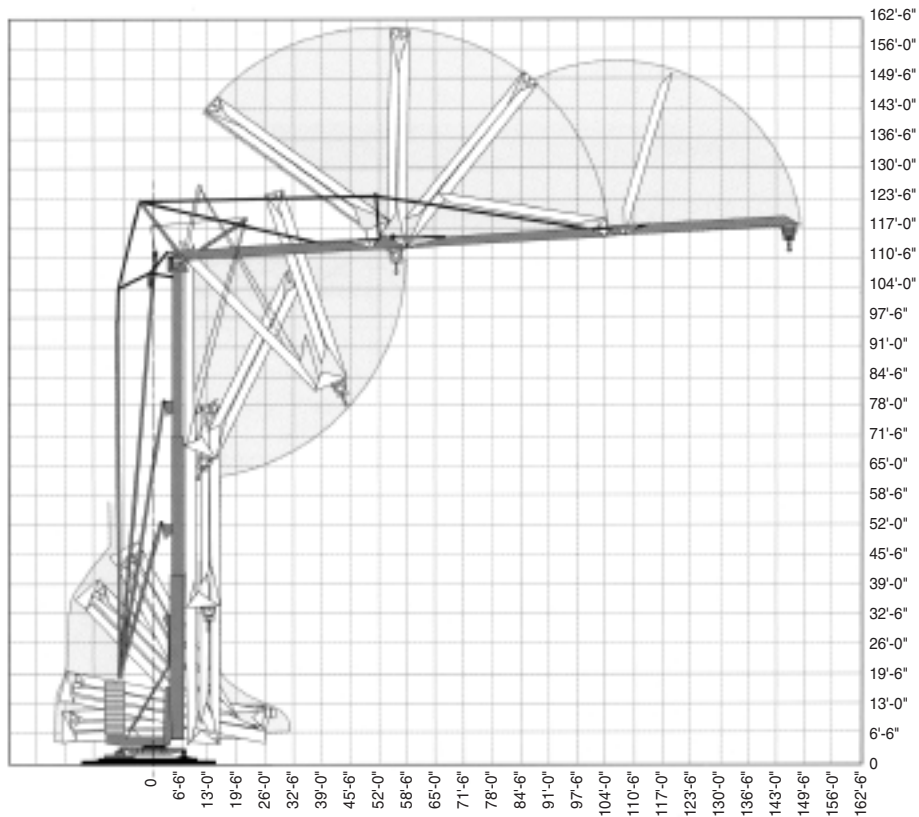

Chassis Data

| | |
|---|-------|
| Overall Length (OAL) (in transport position) | 52'6" |
| Overhang (OH) (in transport position) | 19'1" |
| Overall Height (OAH) (in transport position) | 13'1" |
| Overall Width (in transport position) | 8'2" |

Weights

| | |
|-----------------------------------|-------------|
| Total Crane – with Counter Weight | 138,687 lb. |
| Total Crane – in Transport | 57,992 lb. |
| Fifth Wheel | 17,861 lb. |
| Rear (drive) Axles | 40,131 lb. |
| Crane Counterweight | 81,705 lb. |

HDT80

rated load charts

4



| Jib Configuration: L45 with maximum hook reach of 147'-8" set at 0 degrees | | | | | | | | | | | | | | | | |
|--|------------------|--------|--------|--------|--------|--------|--------|--------|--------|--------|---------|----------|---------|---------|----------|---------|
| Hook Reach (ft) | 11'-6" | 43'-8" | 49'-3" | 55'-9" | 65'-7" | 72'-2" | 77'-9" | 82'-0" | 88'-7" | 98'-5" | 105'-0" | 114'-10" | 121'-5" | 131'-3" | 137'-10" | 147'-8" |
| Reeving | Capacities (lbs) | | | | | | | | | | | | | | | |
| DM | 13,228 | 13,228 | 11,321 | 9,678 | 7,915 | 7,022 | - | 5,975 | 5,423 | 4,740 | 4,365 | 3,880 | 3,605 | 3,241 | 3,031 | 2,756 |
| SM1 | 6,614 | 6,614 | 6,614 | 6,614 | 6,614 | 6,614 | 6,614 | 6,195 | 5,644 | 4,960 | 4,586 | 4,101 | 3,825 | 3,461 | 3,252 | 2,976 |

Maximum Hook Heights at Jib Tip: $H_2 = 112'-2"$, $H_1 = 81'-8"$, $H_0 = 51'-2"$
 Maximum Hook Heights at Jib Foot: $H_2 = 105'-8"$, $H_1 = 75'-2"$, $H_0 = 44'-7"$

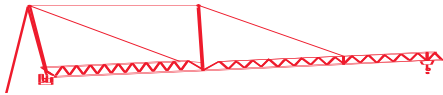

| Jib Configuration: L40 with maximum hook reach of 131'-3" set at 0 degrees | | | | | | | | | | | | | | |
|--|------------------|---------|--------|--------|--------|--------|--------|--------|--------|--------|---------|----------|---------|---------|
| Hook Reach (ft) | 11'-6" | 46'-11" | 49'-3" | 55'-9" | 65'-7" | 72'-2" | 82'-0" | 84'-8" | 88'-7" | 98'-5" | 105'-0" | 114'-10" | 121'-5" | 131'-3" |
| Reeving | Capacities (lbs) | | | | | | | | | | | | | |
| DM | 13,228 | 13,228 | 12,478 | 10,681 | 8,741 | 7,771 | 6,636 | - | 6,030 | 5,280 | 4,861 | 4,332 | 4,034 | 3,638 |
| SM1 | 6,614 | 6,614 | 6,614 | 6,614 | 6,614 | 6,614 | 6,614 | 6,614 | 6,250 | 5,501 | 5,082 | 4,553 | 4,255 | 3,858 |

Maximum Hook Heights at Jib Tip: $H_2 = 111'-6"$, $H_1 = 81'-0"$, $H_0 = 50'-6"$
 Maximum Hook Heights at Jib Foot: $H_2 = 105'-8"$, $H_1 = 75'-2"$, $H_0 = 44'-7"$

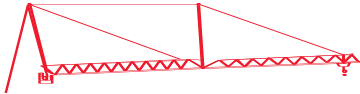

| Jib Configuration: L31 with maximum hook reach of 101'-8" set at 0 degrees | | | | | | | | | | |
|--|------------------|---------|--------|--------|--------|--------|--------|--------|--------|---------|
| Hook Reach (ft) | 11'-6" | 53'-10" | 55'-9" | 65'-7" | 72'-2" | 82'-0" | 88'-7" | 97'-5" | 98'-5" | 101'-8" |
| Reeving | Capacities (lbs) | | | | | | | | | |
| DM | 13,228 | 13,228 | 12,621 | 10,351 | 9,226 | 7,893 | 7,187 | - | 6,316 | 6,063 |
| SM1 | 6,614 | 6,614 | 6,614 | 6,614 | 6,614 | 6,614 | 6,614 | 6,614 | 6,537 | 6,283 |

Maximum Hook Heights at Jib Tip: $H_2 = 110'-2"$, $H_1 = 79'-8"$, $H_0 = 49'-2"$
 Maximum Hook Heights at Jib Foot: $H_2 = 105'-8"$, $H_1 = 75'-2"$, $H_0 = 44'-7"$

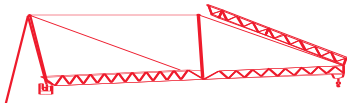

| Jib Configuration: L45 with maximum hook reach of 101'-8" set at 0 degrees | | | | | | | | | | | |
|--|------------------|--------|--------|--------|--------|--------|--------|--------|--------|--------|---------|
| Hook Reach (ft) | 11'-6" | 46'-3" | 49'-3" | 55'-9" | 65'-7" | 72'-2" | 82'-0" | 83'-0" | 88'-7" | 98'-5" | 101'-8" |
| Reeving | Capacities (lbs) | | | | | | | | | | |
| DM | 13,228 | 13,228 | 12,247 | 10,483 | 8,576 | 7,628 | 6,504 | - | 5,908 | 5,181 | 4,960 |
| SM1 | 6,614 | 6,614 | 6,614 | 6,614 | 6,614 | 6,614 | 6,614 | 6,614 | 6,129 | 5,401 | 5,181 |

Maximum Hook Heights at Jib Tip: $H_2 = 110'-2"$, $H_1 = 79'-8"$, $H_0 = 49'-2"$
 Maximum Hook Heights at Jib Foot: $H_2 = 105'-8"$, $H_1 = 75'-2"$, $H_0 = 44'-7"$

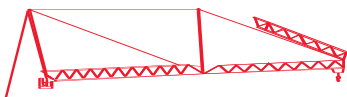

| Jib Configuration: L40 with maximum hook reach of 101'-8" set at 0 degrees | | | | | | | | | | | |
|--|------------------|--------|--------|--------|--------|--------|--------|--------|--------|--------|---------|
| Hook Reach (ft) | 11'-6" | 48'-7" | 49'-3" | 55'-9" | 65'-7" | 72'-2" | 82'-0" | 87'-7" | 88'-7" | 98'-5" | 101'-8" |
| Reeving | Capacities (lbs) | | | | | | | | | | |
| DM | 13,228 | 13,228 | 12,985 | 11,133 | 9,105 | 8,102 | 6,923 | - | 6,283 | 5,512 | 5,291 |
| SM1 | 6,614 | 6,614 | 6,614 | 6,614 | 6,614 | 6,614 | 6,614 | 6,614 | 6,504 | 5,732 | 5,512 |

Maximum Hook Heights at Jib Tip: $H_2 = 110'-2"$, $H_1 = 79'-8"$, $H_0 = 49'-2"$
 Maximum Hook Heights at Jib Foot: $H_2 = 105'-8"$, $H_1 = 75'-2"$, $H_0 = 44'-7"$

HDT80

rated load charts

5

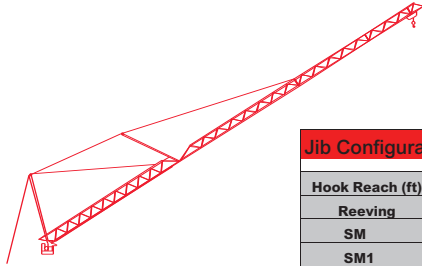

| Jib Configuration: L45 with maximum hook reach of 128'-7" set at 30 degrees | | | | | | | | | | | |
|---|------------------|--------|--------|--------|--------|--------|--------|---------|----------|---------|---------|
| Hook Reach (ft) | 11'-6" | 66'-3" | 68'-3" | 72'-2" | 82'-0" | 88'-7" | 98'-5" | 105'-0" | 114'-10" | 121'-5" | 128'-7" |
| Reeving | Capacities (lbs) | | | | | | | | | | |
| SM | 6,614 | 6,614 | - | 5,941 | 5,049 | 4,564 | 3,968 | 3,649 | 3,230 | 2,987 | 2,756 |
| SM1 | 6,614 | 6,614 | 6,614 | 6,162 | 5,269 | 4,784 | 4,189 | 3,869 | 3,450 | 3,208 | 2,976 |

Maximum Hook Heights at Jib Tip: H₂ = 176'-2", H₁ = 145'-8 "

Maximum Hook Heights at Jib Foot: H₂ = 105'-8", H₁ = 75'-2 "

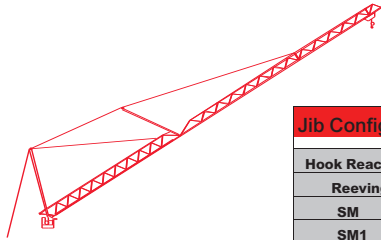

| Jib Configuration: L40 with maximum hook reach of 114'-6" set at 30 degrees | | | | | | | | | | |
|---|------------------|--------|--------|--------|--------|--------|---------|---------|--|--|
| Hook Reach (ft) | 11'-6" | 72'-2" | 74'-2" | 82'-0" | 88'-7" | 98'-5" | 105'-0" | 114'-6" | | |
| Reeving | Capacities (lbs) | | | | | | | | | |
| SM | 6,614 | 6,614 | - | 5,611 | 5,093 | 4,442 | 4,079 | 3,638 | | |
| SM1 | 6,614 | 6,614 | 6,614 | 5,831 | 5,313 | 4,663 | 4,299 | 3,858 | | |

Maximum Hook Heights at Jib Tip: H₂ = 168'-0", H₁ = 137'-6 "

Maximum Hook Heights at Jib Foot: H₂ = 105'-8", H₁ = 75'-2 "

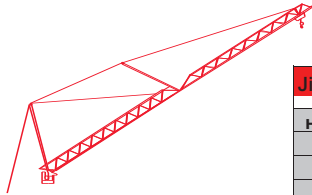

| Jib Configuration: L31 with maximum hook reach of 88'-11" set at 30 degrees | | | | | | | | | |
|---|------------------|--------|--------|---------|--|--|--|--|--|
| Hook Reach (ft) | 11'-6" | 83'-0" | 85'-4" | 88'-11" | | | | | |
| Reeving | Capacities (lbs) | | | | | | | | |
| SM | 6,614 | 6,614 | - | 6,063 | | | | | |
| SM1 | 6,614 | 6,614 | 6,614 | 6,283 | | | | | |

Maximum Hook Heights at Jib Tip: H₂ = 159'-9", H₁ = 129'-3 "

Maximum Hook Heights at Jib Foot: H₂ = 105'-8", H₁ = 75'-2 "

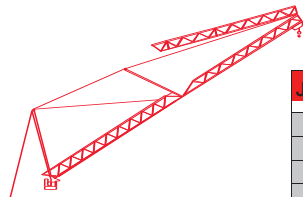

| Jib Configuration: L45 with maximum hook reach of 88'-11" set at 30 degrees | | | | | | | | | |
|---|------------------|---------|--------|---------|--------|---------|--|--|--|
| Hook Reach (ft) | 11'-6" | 70'-10" | 72'-2" | 72'-10" | 82'-0" | 88'-11" | | | |
| Reeving | Capacities (lbs) | | | | | | | | |
| SM | 6,614 | 6,614 | 6,471 | - | 5,501 | 4,960 | | | |
| SM1 | 6,614 | 6,614 | 6,614 | 6,614 | 5,721 | 5,181 | | | |

Maximum Hook Heights at Jib Tip: H₂ = 159'-9", H₁ = 129'-3 "

Maximum Hook Heights at Jib Foot: H₂ = 105'-8", H₁ = 75'-2 "

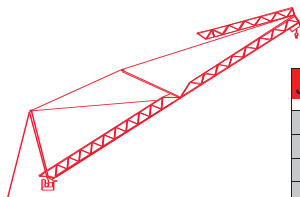

| Jib Configuration: L40 with maximum hook reach of 88'-11" set at 30 degrees | | | | | | | | | |
|---|------------------|--------|--------|---------|--|--|--|--|--|
| Hook Reach (ft) | 11'-6" | 83'-0" | 85'-4" | 88'-11" | | | | | |
| Reeving | Capacities (lbs) | | | | | | | | |
| SM | 6,614 | 6,614 | - | 6,063 | | | | | |
| SM1 | 6,614 | 6,614 | 6,614 | 6,283 | | | | | |

Maximum Hook Heights at Jib Tip: H₂ = 159'-9", H₁ = 129'-3 "

Maximum Hook Heights at Jib Foot: H₂ = 105'-8", H₁ = 75'-2 "

Reeving Abbreviations:

- DM = double block with double reeving
- SM = single block with double reeving
- SM1 = single block with single reeving

Note: The minimum hook radius for all jib configurations is 11'-6".

HDT80

mechanical data

6

| Function | Hoist Type | Speed vs Weight | 2-part | | | | 4-part | | | | Motor (hp) | Motor (kW) |
|----------|------------|-----------------|---------------------------|--------------|--------------|--------------|----------------------------|--------------|--------------|--------------|------------|------------|
| | | | 1st Gear | 2nd Gear | 3rd Gear | 4th Gear | 1st Gear | 2nd Gear | 3rd Gear | 4th Gear | | |
| Hoist | 20 LVF 15 | ft/min lbs | 86 6,614 | 138 3,968 | 171 3,086 | 224 1,543 | 43 13,228 | 69 7,937 | 86 6,173 | 112 3,086 | 20 | 15 |
| | 25 PC 15 | ft/min lbs | 28 6,614 | 111 6,614 | 221 3,307 | | 14 13,228 | 56 13,228 | 111 6,614 | | 25 | 18 |
| Trolley | 5 DVF 5 | ft/min | 30 - 73 - 191 (6,614 lbs) | | | | 30 - 73 - 145 (13,228 lbs) | | | | 6.5 | 4.8 |
| Swing | RVF2-61 | rpm | 0.8 | | | | | | | | 8.0 | 5.9 |

Power Requirements: 480 V (+6% or -10%) 60 Hz measured at turn table.

Amperage: 20 LVF 15: 43 Amp (3 phase service with ground)

Amperage: 25 PC 15: 51 Amp (3 phase service with ground)

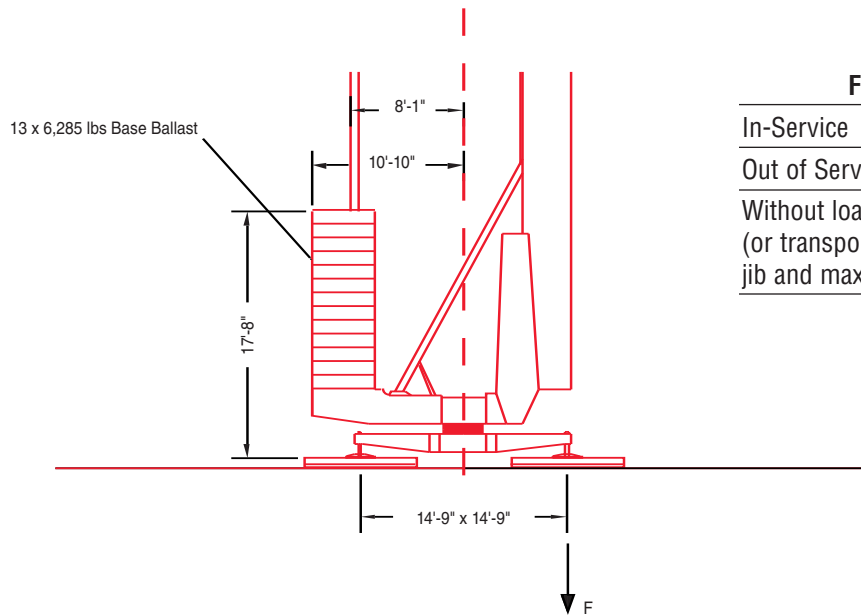

F = Maximum Corner Force

| | |
|---|-------------|
| In-Service | 88,185 lbs. |
| Out of Service | 94,799 lbs. |
| Without load, ballast (or transport axles), with jib and maximum height | 51,600 lbs. |

Warning Systems

Limit Moment Cut-Out – Prevents a moment that is more than +10%.

Warning

1. The operator must read and understand the owner's manual before operating this crane.
2. Positioning or operation of crane beyond areas shown is not intended or approved except where specified in owner's manual.
3. Practical working loads depend on supporting surface, wind, and other factors affecting stability such as hazardous surroundings, experience of personnel, and proper handling, all of which must be taken into account by the operator.

HDT80

CraneCARE is Manitowoc's complete service and support program. Incorporated into this program are service training, immediate parts availability, professional field service, and technical support and documentation. CraneCARE is available for every one of the thousands of cranes operating all over the world.

That's dedication and devotion that you won't get anywhere else.

That's **CraneCARE**.

Service Training

A certified Manitowoc service specialist works with you in your training facility or in the field to ensure that you know how to achieve maximum performance, dependability, and years from your cranes.

A reputable Manitowoc Service technician comes to you to provide valuable training to all distributors on the crane's LMI system.

Parts Availability

Genuine Manitowoc replacement parts may be obtained through your MCG distributor on a regular basis.

Field Service

Factory-trained service experts are always ready to help maintain your crane's peak performance.

For a worldwide listing of dealer locations, please consult our website at:
www.manitowoccrane.com.

Technical Support

Manitowoc's dealer network and factory personnel are available 24 hours a day, 7 days a week, 365 days a year to answer your technical questions and more.

For a worldwide listing of dealer locations, please consult our website at: **www.manitowoccranes.com**.

Technical Documentation

Manitowoc boasts an extensive, easy-to-understand library of documentation.

A complete set of Operator's parts and service manuals are included with each crane.

Additional copies are available through your Authorized Manitowoc Distributor.

7

HDT80

Manitowoc Crane Group - Americas

Manitowoc, Wisconsin Facility
Tel: [Int + 001] 920 684 6621
Fax: [Int + 001] 920 683 6277
Shady Grove, Pennsylvania Facility
Tel: [Int + 001] 717 597 8121
Fax: [Int + 001] 717 597 4062

Manitowoc Crane Group - EMEA

Europe Middle East & Africa
Tel: [Int + 33] (0) 4 72 18 20 20
Fax: [Int + 33] (0) 4 72 18 20 00

Manitowoc Crane Group - UK

Europe Middle East & Africa (Parts & Service)
Tel: [Int + 44] (0) 191 565-6281
Fax: [Int + 44] (0) 191 564-0442

Manitowoc Crane Group - Germany

(Sales, Parts & Service)
Tel: [Int + 49] (0) 2173 8909-0
Fax: [Int + 49] (0) 2173 8909-30

Manitowoc Crane Group - France

France & Africa (Sales, Parts & Service)
Tel: [Int + 33] (0) 1 303-13150
Fax: [Int + 33] (0) 1 303-86085

Manitowoc Crane Group - Netherlands

(Sales, Parts & Service)
Tel: [Int + 31] (0) 76 578 39 99
Fax: [Int + 31] (0) 76 578 39 78

Manitowoc Crane Group - Italy

Italy & Southern Europe (Sales, Parts & Service)
Tel: [Int + 39] (0) 331 49 33 11
Fax: [Int + 39] (0) 331 49 33 30

Manitowoc Crane Group - Portugal

Portugal & Spain (Sales, Parts & Service)
Tel: [Int + 351] (0) 22 968 08 89
Fax: [Int + 351] (0) 22 968 08 97

Manitowoc Crane Group - Singapore

Asia/Pacific excl China (Sales, Parts & Service)
Tel: [Int + 65] 6861-7133
Fax: [Int + 65] 6862-4040 / 4142

Manitowoc Crane Group - Shanghai

China (Sales, Parts & Service)
Tel: [Int + 86] (0) 21-64955555
Fax: [Int + 86] (0) 21-64852038

Manitowoc Crane Group - Beijing

China (Sales, Parts & Service)
Tel: [Int + 86] (0) 10 646-71690
Fax: [Int + 86] (0) 10 646-71691

Manitowoc Crane Group - Middle East

(Sales)
Tel: [Int + 971] (0) 4 348-4478
Fax: [Int + 971] (0) 4 348-4478
(Parts & Service)
Tel: [Int + 973] (0) 9 660-899
Fax: [Int + 973] (0) 2 707-740

Distributed By:

**Manitowoc**
Crane Group



www.manitowoccrane.com

Constant improvement and engineering progress make it necessary that we reserve the right to make specification, equipment, and price changes without notice. Illustrations shown may include optional equipment and accessories, and may not include all standard equipment.